



Dry Rotary Swaging

M. Herrmann^{*1}, H. Hasselbruch², F. Böhmermann³, B. Kuhfuss¹, H.W. Zoch²,
A. Mehner² and O. Riemer³

¹ bime Bremen Institute for Mechanical Engineering, University of Bremen, Badgasteiner Straße 1, 28359 Bremen, Germany

² IWT Foundation Institute for Material Science, Badgasteiner Straße 3, 28359 Bremen, Germany

³ LFM Laboratory for Precision Machining, University of Bremen, Badgasteiner Straße 2, 28359 Bremen, Germany

Abstract

Rotary swaging is an incremental cold forming process for rods and tubes and has a wide spread use in the automotive industry for the manufacture of axles or steering spindles. The advantage of rotary swaging is the optimal use of work piece material resources, due to material strengthening and the ability to manufacture hollow parts with variable wall thicknesses. The established processes use lubricants which fulfil necessary functions such as cooling, washing abrasive particles out of the forming zone and to provide an adequate work piece surface quality. Both, under economic and ecological aspects, the development of rotary swaging towards a dry process layout is highly innovative. To avoid extensive lubrication it is necessary to substitute the above mentioned functions of the lubricant by new innovative approaches. This work shows an interdisciplinary approach for dry rotary swaging, at first a FE modelling and simulation of the rotary swaging process for understanding and designing a dry process. Furthermore, coated tools are presented for the reduction of abrasive and adhesive wear of the tool and structured tools for the control of friction and process forces. At last the combination of both tool modifications is demonstrated.

Keywords: radial forging, structured tools, coated tools

NOMENCLATURE

A	= amplitude	r_0	= initial work piece radius
α	= tool angle	r_1	= final work piece radius
d_0	= initial work piece diameter	Sa	= areal roughness
d_1	= final work piece diameter	s	= deviation
F_A	= axial reaction force	v_f	= feed velocity
$F_{A,max}$	= maximum reaction force	Δx	= tracking error
F_R	= radial forming force	$\Delta x_{theoretical}$	= theoretical tracking error
$F_{R,max}$	= maximum excitation force	x_s	= required position
F_f	= feed force	μ	= coefficient of friction
H	= overall height	μ_{Red}	= coefficient of friction in the reduction zone
h_T	= stroke height	μ_{Cal}	= coefficient of friction in the calibration zone
L	= overall length	I	= reduction zone
λ	= wavelength	II	= calibration zone
k_v	= gain factor value	III	= exit zone
Ra	= roughness		
RONt	= roundness		

1 Introduction

Rotary swaging has an important application in the automotive industry. The incremental cold forming process allows for the reduction of the diameter of rotationally symmetric work pieces, and features advantages like improved material properties as increased tensile strength, undisturbed fibre flow and adjustable wall thickness for hollow shafts. This production process features no waste of work piece material and the optimal use of resources [1].

Incremental forming is carried out by the oscillating movement of the tools with the stroke height h_t . The work piece is axially fed into the swaging unit with a feed force F_f . The force F_f counteracts against the axial reaction force F_A due to the radial forming force F_R in the reduction zone (I) and the tool angle α . To reduce the reaction force conventional tools feature a rough thermally sprayed tungsten carbide layer in the reduction zone to increase the effective friction. At the same time the friction in the calibration zone is low to provide adequate work piece quality. The principle of process variant infeed rotary swaging is shown in Fig. 1.

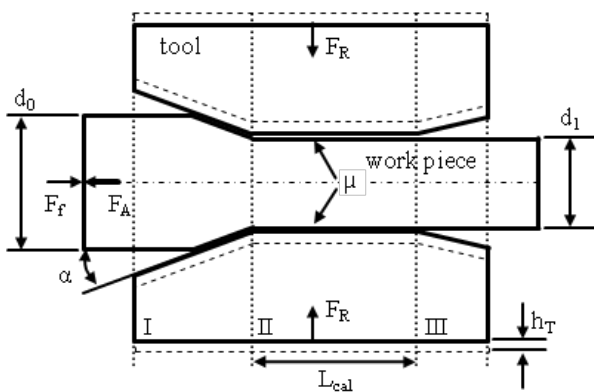

Fig. 1: Principle of rotary swaging process setup and process forces.

Nowadays in case of rotary swaging still a large amount of lubricant based on mineral oil is used. The elimination of lubricant results in three significant advantages: reduction of financial costs, less environmental impacts and possible health burden. For this reason the interest in dry metal forming is increasing [2].

Less process steps like no recycling of lubricant and cleaning of the work piece results in a reduction of costs. Furthermore, the replacement of lost lubricant is unnecessary which is removed during the process, especially for the forming of tubes. Also the machine design is simplified. However, essential functions are fulfilled by the lubricant like the reduction of friction and thus the reduction of tool load and wear. The lubricant serves as separation layer to minimize cold welding processes. In addition it cools the process and flushes the working zone to remove abraded particle.

The feasibility of dry rotary swaging in the micro and macro range was presented [3,4]. The analysis of the recorded process parameters and the formed geometry of the work piece reveals the potential of dry rotary swaging, but also the challenges that arise. The function of the lubricant must be accomplished in another way.

So dry rotary swaging needs a modification of the process and system parameters as well as an adjustment of the tools [4].

A straight way forward to cope with this challenges of dry forming is to control the material flow and thus the required forces by a combination of approaches. In doing so the first approach is the application coated tools to reduce wear on the tools and work pieces. However this creates a conflict, due to the reduction of the coefficient of friction the axial reaction force increases. The commonly used tungsten carbide layer is not applicable any longer because in dry swaging the flushing effect of the lubricant with cleaning the tools from wear particles is missing. So a second modification is a structured tool surface to manipulates the friction between the tools and the work piece. An overview on this interdisciplinary approach is given in Fig. 2.

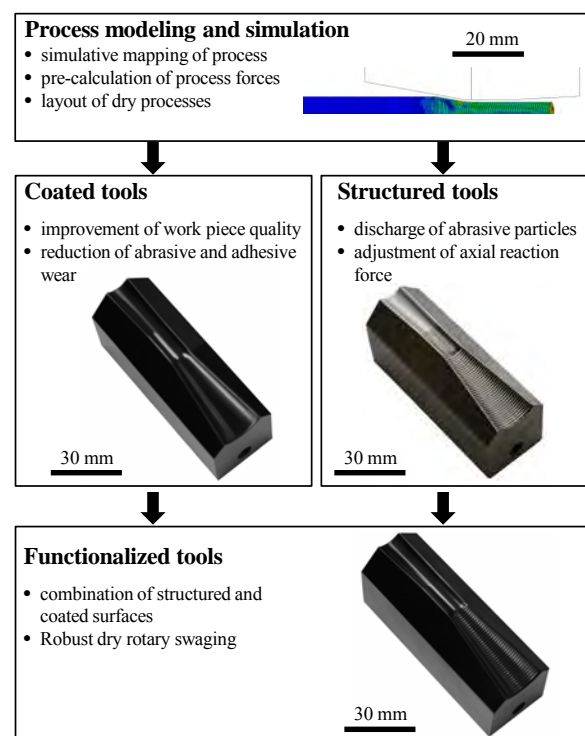

Fig. 2: Interdisciplinary approach for providing a dry rotary swaging process.

This work presents the interdisciplinary approach with research results which are investigated to realize the successful dry rotary swaging. The FE modeling and simulation of the process shows the effect of frictional conditions and structured tool surfaces in the reduction zone. First experimental results with tungsten doped a-C:H coated tools are presented. These thin hard coatings can successfully reduce wear on both, tools and work pieces. Furthermore, structured tools are tested which reduce the axial reaction force. Finally, both tool modifications are combined to facilitate a dry rotary swaging process.

2 Process modeling and simulation

To define suitable tools for a robust dry forming process a further understanding of the rotary swaging

process is necessary. Hence, investigations on the process forces and the energy demand have been carried out with a FE simulation model (see Fig. 3). This 2D-axisymmetric model consists of two parts, the tool as rigid body and the work piece as an elastic-plastic isotropic material with parameters from literature [6]. The implementation is done with the software ABAQUS 6.13-1 (Explicit). The penalty formulation and the coulomb friction is used for the friction model due to the simplicity and the good results in cold metal forming simulations [7]. The coefficient of friction in the reduction and calibration zone of the tool is set to $\mu = 0.1$ derived from the dry process with coated tools or lubricated process with plain tools. For the dry process with plain tools the coefficient of friction is set to $\mu = 0.5$. A 4-node bilinear axisymmetric quadrilateral elements are used with reduced integration and hourglass control. The mesh size is chosen as large as possible to limit the computation time. The geometries for the structured reduction zone are cosine with variation of the wavelength λ and amplitude A (see Fig. 3). For the structured tools the coefficient of friction for all simulations is set to $\mu = 0.1$.

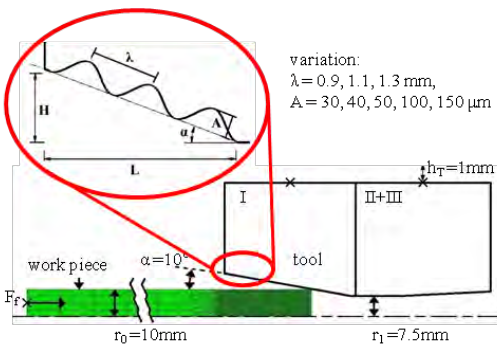

Fig. 3: 2D-axisymmetric model with cosine geometry of the reduction zone.

The considered axial forces are the average of the maximum forces per stroke over the complete quasi-steady state of the process. The quasi-steady state of the process is reached when the complete tool is in contact with the work piece. The results of the comparative simulation without structure, a smooth reduction zone, and a coefficient of friction of $\mu = 0.1$ is set to 100 %. The simulation without structure and a coefficient of friction of $\mu = 0.5$ results in an axial reaction force of 49.9 %. The axial forces F_A are presented versus the amplitude A with the three different wavelengths (see Fig 4). An effect of a structured tool on the axial process force is shown in Fig. 4. While the amplitude of the cosine rises the axial force decreases. Also a taller wavelength leads to a reduction of the axial reaction force. A reduction to $F_A = 34 %$ in comparison to the simulation with smooth tools is achievable for a structure with $\lambda = 1.1$ mm and $A = 0.2$ mm. The axial force is reduced by the advantageous material flow. This is due to the geometry since the flow is less impeded due to the space generated by the cosine geometry as well as the altered distribution of strain.

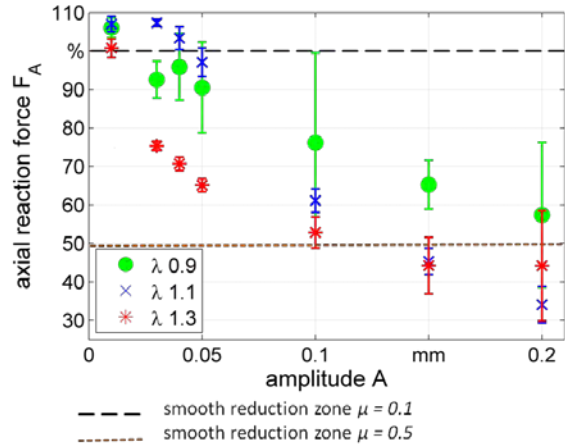

Fig. 4. Axial force from simulation, with structured tools for $\mu = 0.1$ in comparison to smooth tools with $\mu = 0.1$ and $\mu = 0.5$.

3 Coated tools

In order to meet the challenge of lubricant free process conditions low friction hard coatings such as DLC coatings (diamond like carbon) show the most promising wear characteristics [8,9]. A disadvantage of a-C:H films due to the impulsive loadings during rotary swaging could be the low load capacity [10,11]. In consequence, the protection of the structured tools could be adversely affected. For increasing the bearing strength the coating toughness needs to be increased. To promote the adhesion between substrate and upper layers hard Cr/CrN_x layers are used. For further increasing the fracture toughness and the adhesion a tungsten doped a-C:H interlayer is used [12,13]. Two tungsten doped a-C:H variants, Cr/CrN_x/a-C:H:W and Cr/CrN_x/a-C:H:W/a-C:H, were deposited on hardened steel discs (WKN 1.2379) by reactive magnetron sputtering [14].

Both film layouts were studied in pin-on-disc tribometer tests against aluminum (WKN 3.3206) and steel pins (WKN 1.0038) under dry ambient and comparable process conditions. Uncoated discs were tested and used as reference. The pin wear coefficient was evaluated as indication for the work piece quality by measuring the diameter of the pin wear scars with an optical microscope (see Fig. 5).

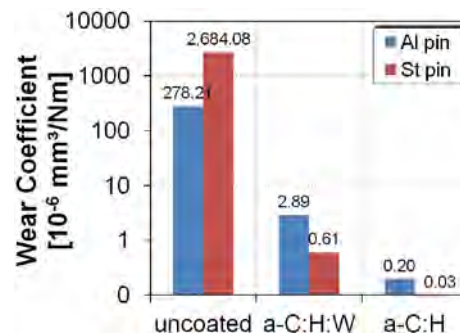

Fig. 5: Wear coefficient of aluminum and steel pins under dry process near conditions: 6 N and 12 N normal force, 20000 cycles, rotational speed of 0.25 m/s.

Compared to both uncoated combinations, the wear could be reduced by more than 3 orders of magnitude

when using the Cr/CrN_x/a-C:H/W/a-C:H film layout. According to the application testing under dry conditions this coating design is used for deposition on tools.

Experiments with conventional tools with a tungsten carbide layer as well as coated tools were carried out. Conventional and coated tools are shown in Fig. 6. To compare the results of the forming process and the work piece quality the same experiments were conducted with a swaging unit HE32 with a linear direct drive which fed the work piece into the swaging unit. Four different feed velocities were tested with and without lubricant. The tools were cleaned each time for the forming without lubricant. The experimental settings are summarized in Table 1.

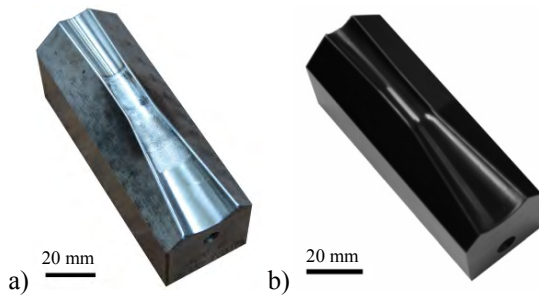

Fig. 5: Rotary swaging tools; a) conventional tool, b) coated tool.

Table 1. Process settings for the experiments.

parameter	value	parameter	value
feed velocity v_f	500, 1000, 1500, 2000 mm/min	work piece material	1.0038, 3.3206
tool material	1.2379, ASP 2023	feed length x	130 mm
tool angle α	10 °	initial diameter d_0	20 mm
tool stroke h_T	1 mm	final diameter d_1	15 mm
stroke frequency f_{st}	35,7 Hz	zone II length l_{cal}	20 mm

The tracking error of the linear direct drive Δx is calculated by the difference between actual value and set value of the feed drive and is measured during the process. Fig. 6 shows the tracking error which was lower for rotary swaging of steel without lubricant. The increase with higher feed velocity is due to the speed-dependent tracking error. The theoretical tracking error $\Delta x_{theoretical}$ is shown in Fig. 6 as well. The tracking error is the smallest for the forming with the conventional tools with the higher friction value due to the tungsten carbide layer. The tracking error is greatest for the forming with lubricant and coated tools due to the lowest friction value.

The surface roughness of a dry formed tube with feed velocity of $v_f = 500$ mm/min and coated tools is $R_a = 0.8 \mu m$, $s = 0.12 \mu m$, one measurement example is shown in Fig. 7. The tube dry formed with $v_f = 500$ mm/min and conventional tools has a average roughness of $R_a = 1.76 \mu m$, $s = 0.13 \mu m$. In summary it can be said, that coated tools lead to a slightly better surface quality of the steel work piece but increase the

tracking error during the process. Both can be explained by the minimization of the coefficient of friction.

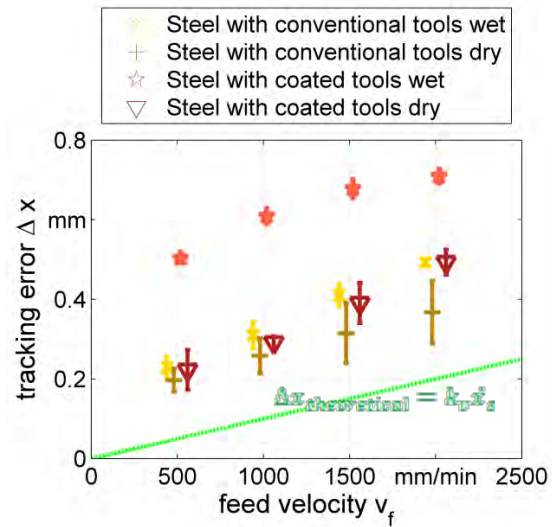

Fig. 6: Tracking error for different feed velocities with/without lubricant for conventional and coated tools.

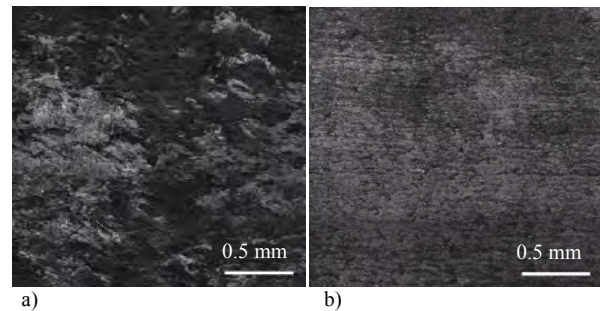

Fig. 7: Steel work piece surface after dry forming ($v_f = 500$ mm/min), measured by laser scanning microscope (LSM); a) with conventional tools, b) with structured tools.

For the forming of aluminum no investigations with conventional tools were done, because the tungsten carbide layer will be clogged immediately by the aluminum. So the dry experiments are done with a tool with a complete smooth reduction zone. A high amount of adhesion on the tool could be recognized and the work piece quality was disadvantageous, see Fig 8 a). After the dry forming of aluminum with coated tools substantially less adhesion was found. The coated tools were examined by scanning electron microscopy (SEM) and no coating failure could be observed. However, a few aluminum adhesion by means of EDX analyzes could be detected. The adhesion occurs primarily along the hard-milling grooves, see Fig. 8. The work piece quality is much better, see Fig 9 b), so for example the roundness, $RON_{t_{smooth}} = 83 \mu m$ in comparison to $RON_{t_{coated}} = 24 \mu m$. Also the roughness is better by the factor of seven. In summary it can be said, that coated tools only permit a dry rotary swaging, especially fro aluminum.

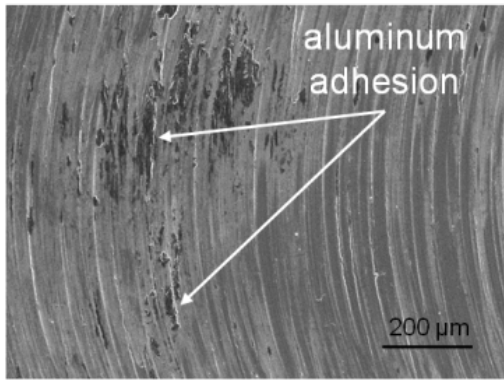

Fig. 10: SEM image of the reduction zone (I) with aluminum adhesion of a coated tool.

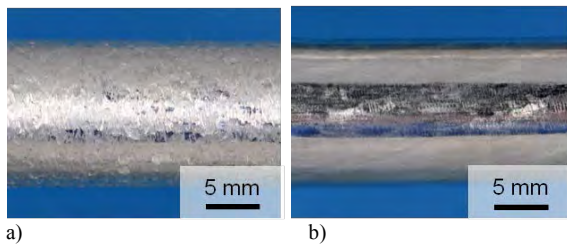

Fig. 9: Work piece surface after dry forming of aluminum ($v_f = 500$ mm/min); a) with smooth tools, b) with structured tools.

4 Structured tools

A theoretical approach of structured rotary swaging tools in order to reduce the axial reaction force F_A was shown before [15]. To investigate structured tool samples under conditions similar to the actual rotary swaging process, a new process near test rig has been developed, see Fig 11 [16]. Therefore the geometries of the tools and work pieces as well as the impact loads of the process are applied to the test rig. Fig. 12 shows the results of the experiments with the test rig for three tool samples, a polished reference tool sample (roughness $S_a = 10$ nm) dry and wet and a structured tool sample dry with a cosine surface structure with wavelength $\lambda = 1.3$ mm and amplitude $A = 150$ μ m.

This conditions is also used for the simulation in chapter 2. For all experimental variants the measured maximum reaction force $F_{A,max}$ is less than the maximum excitation force $F_{R,max}$ because of the deformation energy for the work piece samples. The highest axial reaction force $F_{a,max} = 50$ kN was measured for the lubricated experiment with a polished reference tool sample. All dry experiments lead to lower reaction forces of less than $F_{a,max} = 10$ kN, due to the higher friction. The structured samples allow to increase the friction compared to the polished sample under dry conditions and show the lowest deviation of the measured reaction force.

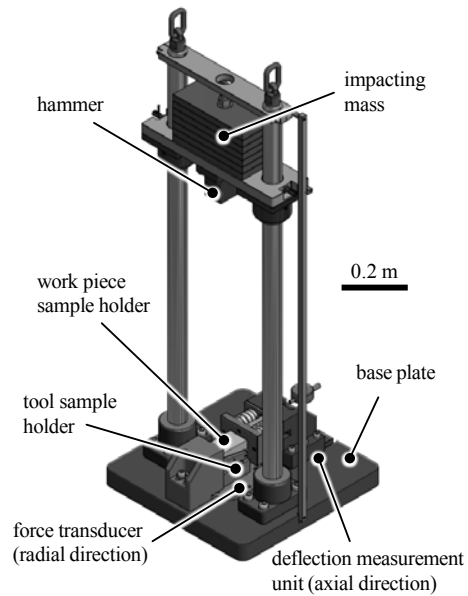

Fig. 11: Setup of the test rig for the tribological investigation of micro structured surfaces [16].

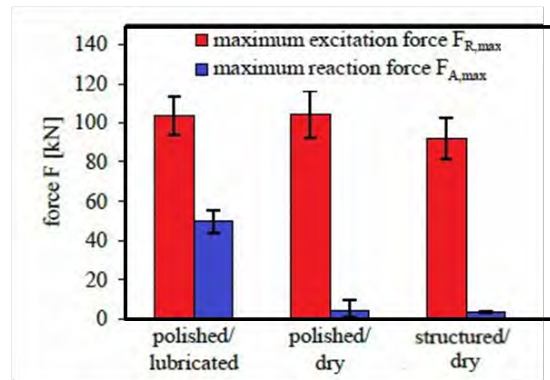

Fig. 12: Measured maximum excitation force $F_{R,max}$ and maximum reaction force $F_{A,max}$ for various tool sample surfaces and conditions (lubricated/dry).

Tools with structured surfaces in the reduction zone (see Fig. 13) were investigated in rotary swaging experiments applying the same settings as highlighted in chapter 3. The cosine structures like for the tool sample are applied on the tools. The tracking error and thus the axial reaction force is lower when forming steel without lubricant in comparison to forming with lubricant (see Fig. 13). For the conventional tools rotary swaging with lubricant generates the highest tracking errors due to the lowest coefficient of friction. The structured tools generate a lower tracking error and the lowest tracking error deviation. The lubrication condition has a very small influence when the structured tools are applied but for dry forming the tracking error is slightly lower. In summary, structured tools reduce the tracking error and thus also the axial reaction force.

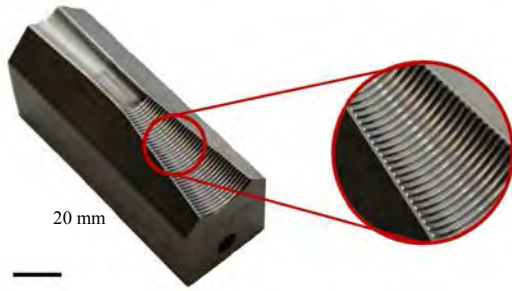

Fig. 12: Structured rotary swaging tool.

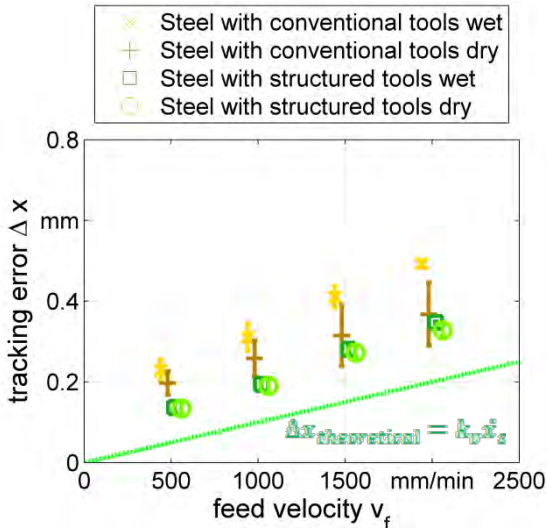

Fig. 13: Tracking error for different feed velocities with/without lubricant for conventional and structured tools.

After the forming with structured tools the surfaces have considerably lower quality compared to the forming with conventional tools (see Fig. 14). A transfer of the cosine structure of the tools reduction zone into the surface of the work pieces was observed. They occur for both lubrication conditions. This transferred structure return in regular intervals like at the cosine structure of the tools. The regular surface finish produced in the calibration zone of the tools is not possible anymore due to the strong disruption.

For the dry forming of aluminum also a high amount of adhesion was recognized on the structured but uncoated tools. So the work piece quality was disadvantageous and valleys are to be found in peripheral direction transferred by the structure.

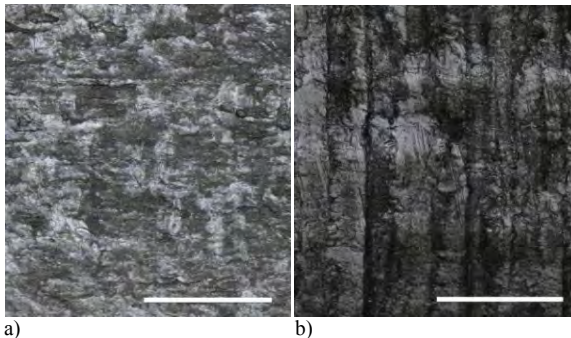

Fig. 14: Work piece surface after dry forming with $v_f = 500$ mm/min, measured by LSM; a) with conventional tools $R_a = 1 \mu\text{m}$, b) with structured tools $R_a = 2.9 \mu\text{m}$.

5 Functionalized tools

Finally both approaches are combined in a tool set shown in Fig. 15. The coating layout described in chapter 3, was deposited on structured tools. The structure is chosen with a smaller amplitude $A = 50 \mu\text{m}$ and the same wavelength $\lambda = 1.3 \text{ mm}$ like the tools tested in chapter 4, with the aim to reduce the molding of tool's surface structures into the work piece and therefore to achieve better surface qualities. The test settings remained unchanged.

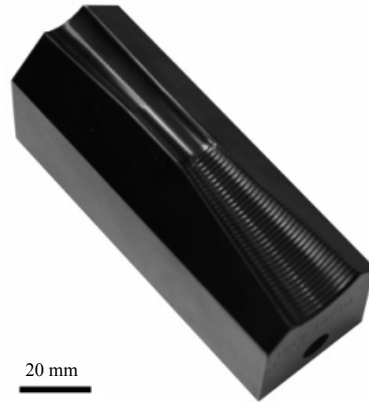

Fig. 15: Functionalized rotary swaging tool.

At first the experiments are carried out with aluminum. The coated and structured tools were examined by SEM and for this tools coating failure could be observed by means of EDX analyzes, see Fig. 16. On the one hand at some parts the a-C:H:W layer is surfacing, on the other hand the cold working steel of the tool can be seen. This coating failure is mostly located at the top of the structure. Furthermore, a few aluminum adhesion could be detected. This can be explained by the higher stress during the forming due to the changed conditions by the structure.

Future work in this research will incorporate analysis if process data and surface quality of formed work pieces as well as swaging experiments with steel tubes.

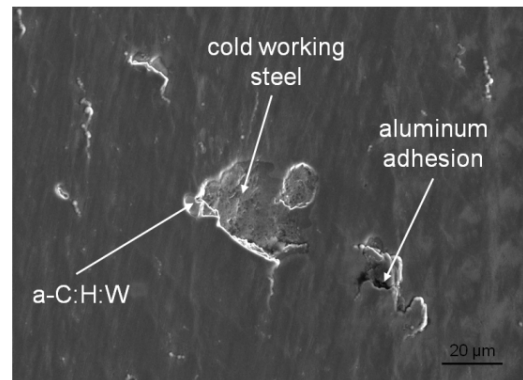

Fig. 16: SEM image of the reduction zone (I) of a coated and structured tool, with aluminum adhesion and coating failure.

6 Conclusion

This work presents the interdisciplinary research results according to dry rotary swaging. Forming with functionalized tools with and without lubricant in comparison to conventional forming is studied for steel and aluminum. The process parameters and the formed geometry are examined. The feasibility is partially shown and also the difficulties that arise. Following conclusions are drawn:

- FEM simulation showed, that structured tools with a cosine shape reduce the axial force with higher amplitude while the radial force is barely influenced.
- Forming with structured tools leads as expected to a decrease of the tracking error and thus the axial reaction force.
- The work piece quality of dry formed work pieces is disadvantageous, due to insufficient roundness and roughness. Especially tubes formed with tools with cosine structure exhibit strong disruption at the surface.
- Coated tools without structure showed no coating failure after the forming of aluminum. Due to the dry experiments, it was demonstrated that coated tools improve the work piece quality.
- In contrast coated and structured tools showed coating failure after the forming of aluminum.

All investigations show a progress straight forward into the development and implementation of lubricant free rotary swaging processes. In future work an adjustment of structuring and coating is required. The structured tools have a big impact on the surface quality of the work piece. Therefore, a smaller structure has to be found which leads still to a decrease of the tracking error while the influence on the surface is minimized. One idea is to apply cosine structures to the reduction zone of tools, that exhibit a continuous decreasing amplitude towards the calibration zone. In addition, a skewed cosine structure should be of interest due to the potential to have the same positive reducing influence on the tracking error while smaller amplitude.

To further improve the coating, various tungsten gradings at the CrN- and a-C:H interface are currently under investigation as well as a duplex treatment by a previous nitriding of the tool steel. Also the influence of the deposition parameters to the mechanical properties of a-C:H functional layer will be tested. Additionally the surface of the tools will be polished to minimize the roughness and to reduce stresses introduced by the hard milling process. Furthermore, the structure and the coating need to be matched to each other. Also the change of the temperature conditions due to the missing cooling of the lubricant needs further investigations.

Acknowledgements

The authors would like to thank the German Research Foundation (DFG Deutsche Forschungsgemeinschaft) for funding this work within the subproject "Potentials of Dry Rotary Swaging" of the priority program SPP 1676 "Dry metal forming - sustainable production through dry processing in metal forming".

References

- [1] B. Kuhfuss, E. Mouri, Incremental Forming. In: F. Vollertsen, editors, *Micro Metal Forming*, Springer Berlin; 2013, p. 104-113.
- [2] F. Vollertsen, F. Schmidt, Dry metal forming: Definition, chances and challenges, *International Journal of Precision Engineering and Manufacturing - Green Technology*, 2014, 1: 59-62.
- [3] E. Mouri, Influences of dry machining on micro rotary swaging, 4th International Conference on Nanomanufacturing, 2014.
- [4] M. Herrmann, C. Schenck, B. Kuhfuss, Dry rotary swaging - tube forming, *Key Engineering Materials*, 2015, 651-653: 1042-1047.
- [5] E. Mouri, S. Ishkina, B. Kuhfuss, T. Hochrainer, A. Struss, M. Hunkel, *Procedia Engineering*, 2014, 81, 2342-2347
- [6] E. Doege, H. Meyer-Nolkemper, I. Saeed, "Fließkurvenatlas metallischer Werkstoffe", 1986, Hanser Verlag, Wien.
- [7] T Xincai, Comparisons of friction models in bulk metal forming, *Tribology International*, 2002, 35: 385-393.
- [8] A. Ghiotti, S. Bruschi, "Tribological behaviour of DLC coatings for sheet metal forming tools", *Wear*, Vol. 271, pp. 2454 - 2458, 2011.
- [9] P. Carlsson, M. Olsson, "PVD coatings for sheet metal forming processes - a tribological evaluation", *Surface and Coating Technology*, Vol. 200, pp. 4654 - 4663, 2006.
- [10] H. Hetzner, "Systematische Entwicklung amorpher Kohlenstoffschichten unter Berücksichtigung der Anforderungen der Blechmassivumformung", dissertation, University of Erlangen (2014)
- [11] M. Weber, K. Bewilogua, H. Thomsen, R. Wittdorf, „Influence of different interlayers and bias voltage of a-C:H and a-C:H:Me coatings prepared by reactive d.c. magnetron sputtering”, *Surface and Coatings Technology*, Vol. 201, pp. 576-1582, 2006
- [12] X. Chen, Z. Peng, Z. Fu, S. Wu, W. Yue, C. Wang, "Microstructural, mechanical and tribological properties of tungsten-gradually doped diamond-like carbon films with functionally graded interlayers", *Surface and Coatings Technology*, Vol 205, pp. 3631-3638, 2011
- [13] A. Czyzniewski, "Optimising deposition parameters of W-DLC coatings for tool materials of high speed steel and cemented carbide", *Vacuum*, Vol. 86, pp. 2140-2147, 2012
- [14] H. Hasselbruch, M. Herrmann, A. Mehner, H. W. Zoch, B. Kuhfuss, Development, characterization and testing of tungsten doped DLC coatings for dry rotary swaging, *MATEC*, 2015, 21: 08012.
- [15] N.N., "Forming Tool, in particular Kneading Tool," International Patent No. WO 2010/105826 A1, date: 18.03.2010.
- [16] M. Herrmann, H. Hasselbruch, F. Böhmermann, B. Kuhfuss, H. W. Zoch, A. Mehner, O. Riemer, Potentials of Dry Rotary Swaging, *Dry Metal Forming OAJ FMT*, 2015, 1: 63-71.]