



Inductive heat treatment as an alternative tempering method for the selective oxidation of 1.2379 tool steel surfaces

S. Schöler*¹, D. Wulff¹, D. Yilkiran², B.-A. Behrens²

¹Institut für Werkstoffkunde, Leibniz Universität Hannover, 30823 Garbsen, Germany

²Institut für Umformtechnik und Umformmaschinen, Leibniz Universität Hannover, 30823 Garbsen, Germany

Abstract

Selective surface oxidation of a hardened conventional tool steel (1.2379) was carried out with controlled oxygen partial pressures at elevated temperatures. In order to obtain a defined oxygen partial pressure, the experiments were carried out under pure nitrogen and silane doped nitrogen atmosphere. Depending on the actual heat treatment parameters, morphologically different iron based oxide systems could be generated. Some of the selectively oxidized surfaces featured advantageous tribological properties, which appear suitable for lubricant free forming applications. For selected oxide layer systems a batch process for the heat treatment was developed. This set-up is described including the sensitive process control with respect to gas composition. The oxide layer systems generated were characterized by analyzing their composition and surface morphology. In addition, an inductive heat treatment procedure was developed. With this hybrid approach mixed layer systems could be realized that combine different characteristics of conventionally oxidized specimen surfaces.

Keywords: surface analysis, heat treatment, selective oxidation, friction, tribology

1 Introduction

Ecological and economic objectives become more and more significant in modern industrial manufacturing. Regarding the process chain of metal forming processes, dry metal forming is defined as a manufacturing process, which concentrates on the aspect of production without any cleaning procedure in ensuing processing steps [1]. The present study examined lubricant free dry metal forming with a focus on deep drawing processes. In this context, the contact of tool surface and work piece has to be investigated in detail, to understand the tribological system, where wear is conventionally minimized by addition of lubricants. The latter are ecological polluting products, which are inconsistent with requirements of sustainable production and extend process chains in terms of additional cleaning steps.

With respect to sustainability in modern manufacturing, the use of selectively oxidized tool steel surfaces to allow lubricant free forming is very attractive. The specific loading case of deep drawing processes studied here is, however, very complex, but depends in general on friction. Thus, the friction behaviour of

selectively oxidized tool steel surfaces was investigated along with the wear behaviour in related studies [2, 3]. It was observed that under certain conditions, low friction behaviour and good wear resistance could be realized. In the present study, the design of a batch process, which allows to tune the process atmosphere sensitively by controlling its oxygen partial pressure, is described in detail. With this approach, the effect of the composition of the atmosphere and the heat treatment concept on the properties of the oxide layer formed on the tool steel could be studied.

2 Selective Oxidation

The reducibility of an oxide system for a given oxygen partial pressure and temperature can be defined as a function of its free enthalpy of formation $\Delta_f G$. For selected oxide systems the corresponding thermodynamic data are given in form of a so-called Ellingham-diagram in Fig. 1. An oxide system is stable for conditions above the curve of the specific oxide considered. For iron-oxide-systems, those conditions can be located for an oxygen partial pressure higher than

10^{-6} atm at temperatures between 500 °C and 700 °C (intersections of red marks).

For steels, the base metal can typically react to four different types of iron oxides, specifically hematite (α -Fe₂O₃), maghemite (γ -Fe₂O₃), magnetite (Fe₃O₄) and wüstite (FeO), [4]. Given to components of the tool steel used (1.2379), however, especially chromium oxides are even more stable thermodynamically at elevated temperatures compared to those of iron. Thus, chromium oxides can also be formed on the surface, even though chromium is only present in the alloy with minor concentration. Consequently, mixed oxide layer are often present on tool steel components during the heat treatment in oxygen containing process gases [5].

In previous experiments, silicane oxide systems were generated on the steel surfaces with addition of monosilane as a reducing gas for limiting oxygen and water residues.

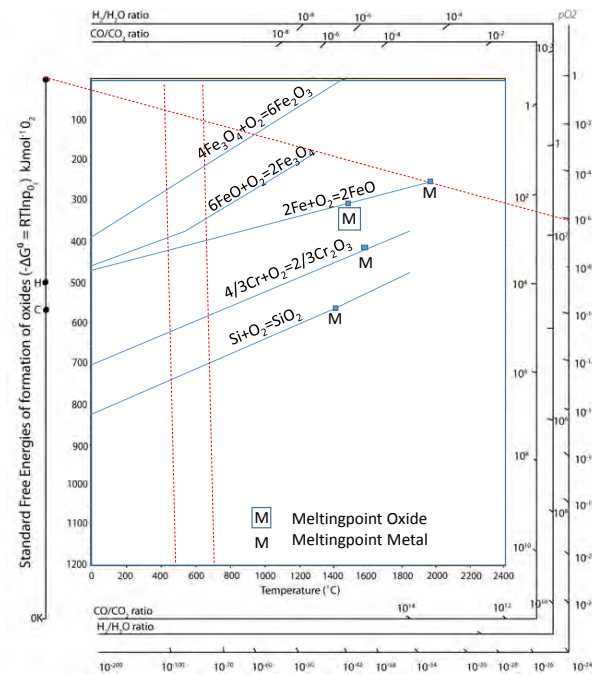

Fig 1: Ellingham diagram for selected oxide systems [6]

The Ellingham-diagram does not consider any kinetics of the formation of the oxide systems, i.e. a thermodynamically favourable oxide system may not form under given process conditions. In the present study, this effect exploited by using certain temperature-time-regimes. Specifically a short rise of temperature above annealing temperature of the 1.2379 specimen used was used to trigger selective oxidation and at same time avoid detrimental effects on the mechanical properties in the bulk of the tempered specimen.

These short temperature excursion were realized using the skin effect of eddy currents, which are typical of inductive heating. The depth that eddy currents penetrate into a material is affected by the frequency of the excitation current, the electrical conductivity ρ and magnetic permeability μ of the specimen. The depth of penetration decreases with increasing frequency f , conductivity and magnetic permeability. The depth at which the eddy current density has decreased to 1/e of the

surface density, is called the standard depth of penetration δ , which can be described as:

$$\delta = \sqrt{\frac{2\rho}{2\pi f\mu}} \quad (1)$$

Obviously, higher surface temperature will result in higher surface activation and could favour selective oxidation. However, the generation of a homogeneous selectively oxidized layer represents a special challenge. Specifically, chromium carbides present on the tool steel surface obstruct the homogeneous covering of the surface by the oxide layer. Chromium carbides result from preceding hardening of the tool steel. Figure 2 shows an elemental mapping using energy dispersive spectroscopy of X-ray (EDX) of a representative selectively oxidized specimen surface, which was heat treated under monosilane doped nitrogen for 15 minutes at 500 °C. The probed area is shown with secondary electron (SE) contrast in the left image at the top. From the EDX data it is clear that these precipitates are chromium-rich carbides. At the same time, the SE image demonstrates that the chromium carbides are not covered by oxides (Fig. 2 top left).

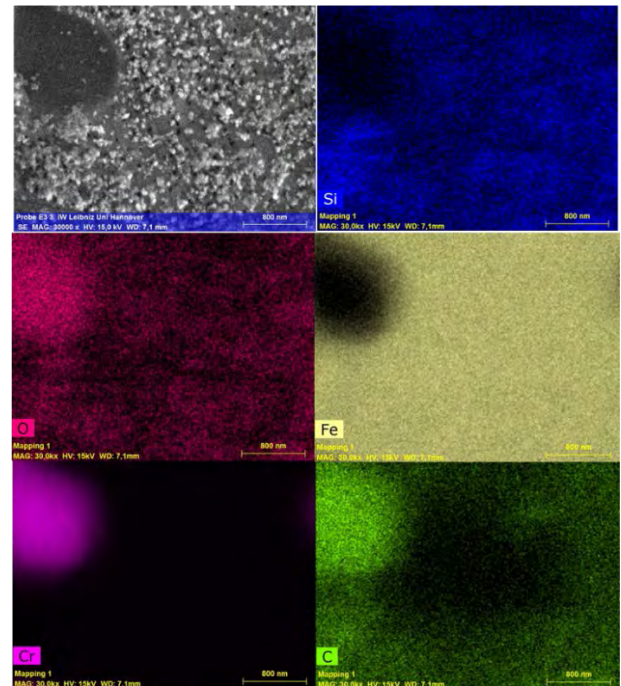

Fig 2: EDX elemental maps of a specimen surface convectively tempered under a monosilane doped nitrogen atmosphere; the top left SE image demonstrates that chromium carbides are not covered by oxides

3 Experimental Details

For the experiments rotation-symmetric specimens (length 50 mm, diameter 16 mm) made of hardened (58HRC) tool steel (EU alloy grade 1.2379 X153CrMoV12) with a nominal composition of 84.75 wt.-% Fe, 12.00 wt.-% Cr, 1.55 wt.-% C, 0.90 wt.-% V and 0.80 wt.-% Mo were used. They were machined according to the geometry shown in Fig. 3 with circular

ground surfaces with an average roughness of $R_a = 0.2 \mu\text{m}$.

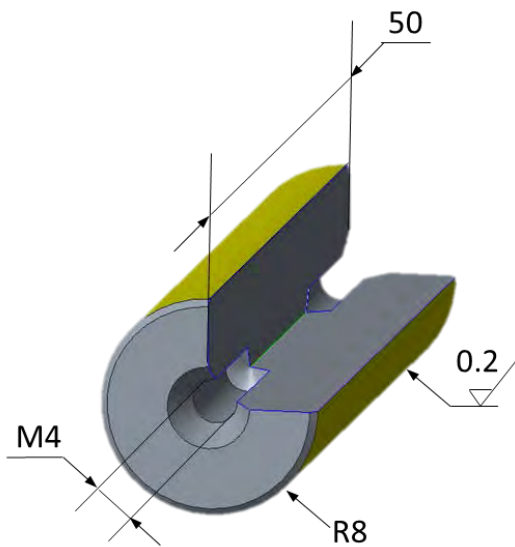

Fig 3: Planar sectional view of the tool specimen (1.2379)

In the present study, a new method for selective oxidation of the specimens was developed. In this batch process, stationary conditions were obtained by controlling the gas flow, the composition of the atmosphere and the process temperature (Fig. 4). The process was realized by a tube furnace with three convective heating zones, which allow conventional tempering. The oxygen partial pressure was measured by a lambda probe, which controls the partial pressure of oxygen. In addition, an inductor was installed, so that both methods of heat treatment of the specimen can be realized under constant atmosphere and results compared to each other. The system designed is equipped with a gas panel, which allows to premix nitrogen with monosilane using mass flow controllers (MFC) and diaphragm valves (V1 in Fig. 4). For selective oxidation an oxygen content of 0,03 % was determined to be suitable, which corresponds to a measured lambda probe voltage of about 125 mV. The best gas flow for this composition was reached for a rate of 25 SLPM for pure nitrogen streaming in. For monosilane doped Nitrogen 15 SLPM were sufficient at a recipient volume of 50 litres.

The coupled electrical power included between 1500 and 3000 W, with corresponding frequencies of the induction system between 250 and 500 kHz.

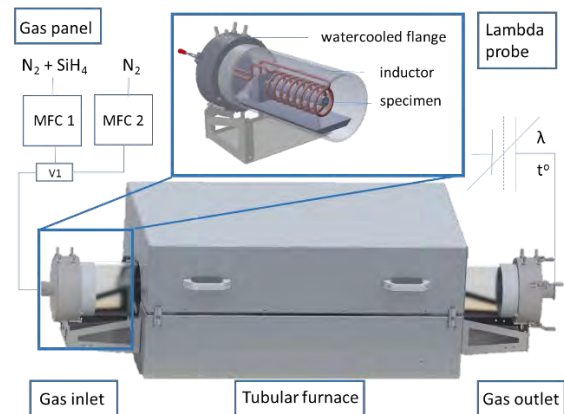

Fig 4: Setup of the system used for selective oxidation that combines induction and convective heating

Based on previous investigations for the parameterization of the selective oxidation process under continuous conditions, two sets of parameters were employed in the tube furnace that favour the formation of SiO_2 and iron oxide layer systems on the specimens surfaces. Figure 5 sketches the two basic temperature-time regimes employed. Inductive heating included a maximum temperature of $700 \text{ }^\circ\text{C}$ with a heating rate of $5 \text{ }^\circ\text{C/s}$ (dashed line) and convective heating with a heating rate of $0.15 \text{ }^\circ\text{C/s}$ (solid line) under monosilane doped nitrogen were used. For both methods the specimen were kept at elevated temperature ($\geq 500 \text{ }^\circ\text{C}$) for 15 minutes, prior to cool down (Fig. 5).

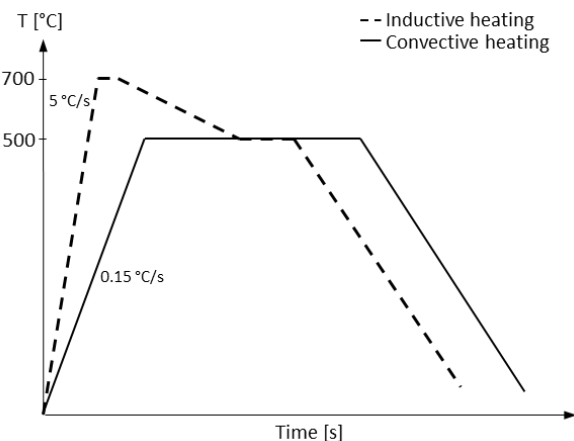

Fig 5: Temperature-time regimes of the two different heat treatment methods used

Inductive tempering could be conducted with pure nitrogen and under monosilane doped nitrogen. The combination of both heating methods allows the formation of stable silicone oxides by absorption from the atmosphere to the specimen surface and oxidation of Fe. Thermodynamically, chromium oxides in form of oxidized precipitations are also stable under these conditions. Probably decreasing surface activity could favour this and eventually yield a combination of different oxides in the form of a mixed layer system.

4 Result and discussion

The specimen surface showed tempering colors as it is typical after selective oxidation. The convectively tempered specimen, which was oxidized under monosilane doped nitrogen shows a dark brown structured surface (Fig. 6). The initial milled surface of the specimen is still recognizable and can clearly be located by light reflections at the edge of the specimen, which indicates a very thin oxide layer. SEM analysis were performed using a very low acceleration voltage of 3 kV to minimize excitation of the substrate underneath. The SEM micrograph shown in Fig. 6 demonstrate that the thin oxide layer is constituted of closely spaced nodules. In between those particles, the substrate is still visible, so that the thickness of the oxide layer could be characterized on the basis of the average particle cross section dimension, which is about 100 nm. The generated layer is visually similar to SiO_2 layer systems observed in previous investigations under continuous conditions [2]. Near the top left corner of the SEM image a small area, which is not covered by the oxide layer, is visible. As discussed above (Fig. 2) this is a result of chromium carbide precipitation at this position.

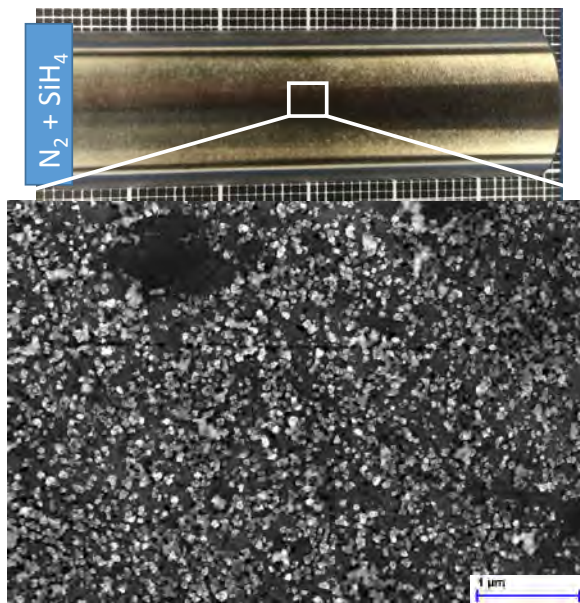

Fig 6: top: specimen after convective heat treatment in silane doped atmosphere (500 °C/15 min., oxygen content 0.03%); bottom: SEM micrograph of the specimen's surface

The specimen that was heat treated inductively up to 700 °C showed typical violet appearing tempering colors (Fig. 7). Visually, the surface seems to be completely covered by a very homogeneous oxide layer. The SEM micrographs revealed that a different kind of morphology in which the growth of the oxide layer occurs by amorphous connections along the grain boundaries all over the probed area. The substrate is still visible, but the thickness of the thin layer can no longer be measured accurately. Essentially, the oxide likely consists of $\alpha\text{-Fe}_2\text{O}_3$, which is accord with previous studies [2].

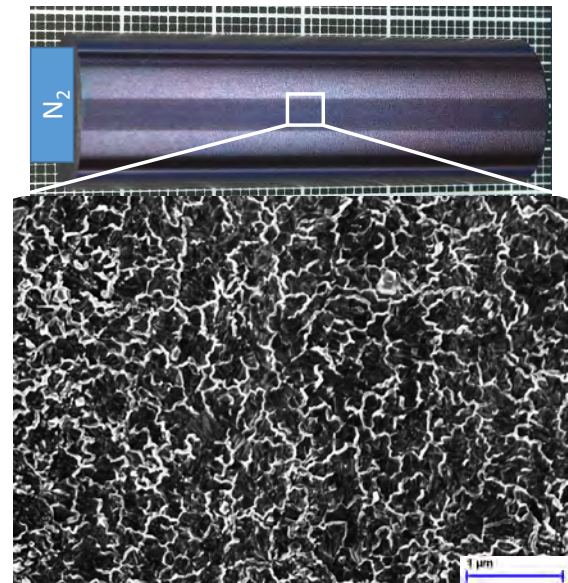

Fig 7: top: specimen after inductive heat treatment in pure nitrogen atmosphere; bottom: SEM micrograph of the specimen's surface

The surface of the specimen, which was tempered inductively up to 700 °C under monosilane doped nitrogen at an oxygen content of 0.03 % shows characteristics of both oxide layers (Fig. 8). The amorphous chain structures at the grain boundaries can be detected as well as particles with a nodular form. However, these appear to have significantly coarsened in contrast to the ones formed by selective oxidation at 500 °C. Obviously, these oxidation conditions have resulted in a more complex layer system, whose thickness is difficult to determine, although the underlying substrate is still visible at some spots.

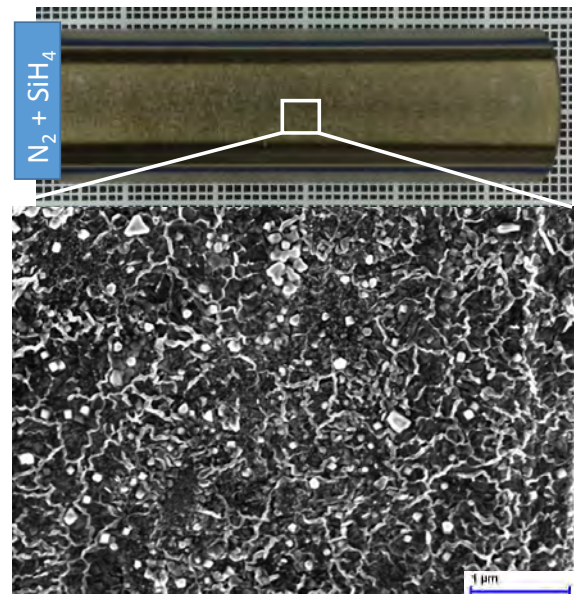

Fig 8: top: specimen after inductive heat treatment in a silane doped atmosphere; bottom: SEM micrograph of the specimen's surface

To get detailed information about the composition of the layer, EDX mappings were conducted. From Fig. 9 it is clear that Fe and Si are mostly localised in the same area. At the same time, the occasional enrichment of chromium coincides with C, Mn and V, indicating carbide precipitation. The appearance of chromium can be attributed to the previous hardening heat treatment. Interestingly, the surface is covered by the oxide layer even in areas where chromium carbides are present on the surface. Oxygen can be detected all over the probed area, which indicates an oxide layer system of different types of oxides. Obviously the new heat treatment approach allows to selectively oxidize the tool steel despite local variations in chemical composition.

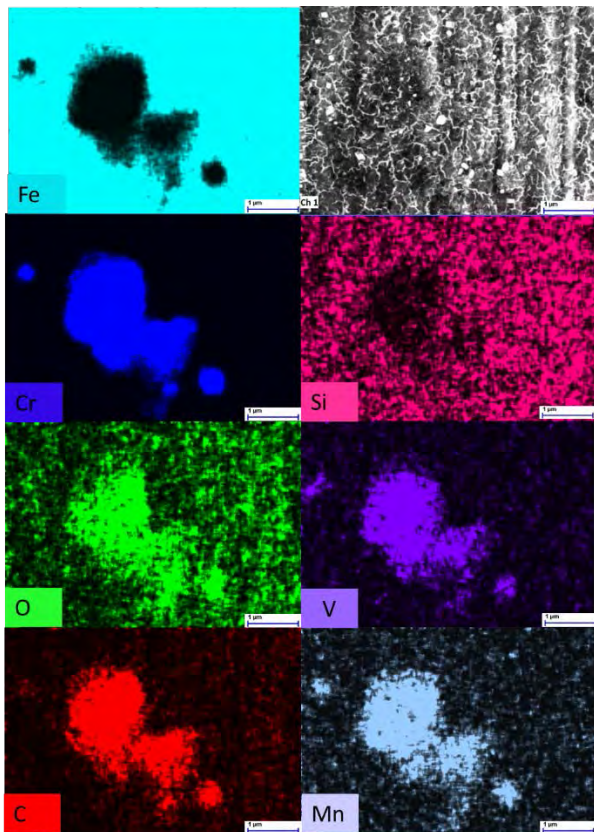

Fig. 9: Chemical composition of an inductively tempered specimen surface under monosilane doped nitrogen atmosphere as determined by EDX analysis; top right: corresponding SEM image

5 Conclusions

The results of the present study can be summarized as follows:

- A batch process was developed to selectively oxidize tool steel with tailored process parameters in terms of environmental conditions and temperature-time profiles.
- The combination of conductive and inductive heat treatment allows coverage of the surface by oxides despite local variations on chemical composition. Specifically, near-surface chromium carbides can be covered as well.
- The combined heat treatment approach results in formation of mixed oxide layer systems.

Acknowledgements

Financial support of this study by the German Research Foundation (DFG) (reference numbers BE1690/170-2 and MA1175/41-2) within the framework of the priority programme *Sustainable Production through Dry Processing in Metal Forming* (SPP 1676) is gratefully acknowledged.

References

- [1] F. Vollertsen, F. Schmidt: Dry Metal Forming: Definition, Chances and Challenges. *Int. J. Precision Engineering and Manufacturing – Green Technology* 1/1 (2014) 59-62.
- [2] D. Wulff, D. Yilkiran, U. Holländer, D. Lützenkirchen-Hecht, R. Wagner, S. Hübner, K. Möhwald, H. J. Maier, B.-A. Behrens: Selective oxidation of 1.2379 tool steel surfaces – an approach for Dry Metal Forming, *Dry Met. Forming OAJ FMT 1* (2015) 72-78.
- [3] D. Yilkiran, A. Almohallami, D. Wulff, S. Hübner, M. Vucetic, H. J. Maier, B.-A. Behrens: New Specimen Design for Wear Investigations in Dry Sheet Metal Forming, *Dry Met. Forming OAJ FMT 2* (2016) 62-66.
- [4] J.O. Edstrom: The mechanism of reduction of iron oxides. *J Iron Steel Inst* 175 (1953) 289–304.
- [5] V.B. Trindade, R. Borin, B.Z. Hanjari, S. Yang, U. Krupp, H. J. Christ: High-temperature oxidation of pure Fe and the ferritic steel 2.25Cr1Mo. *Mat. Res.* 8 (2005) 365-369.
- [6] A. Paul: Chemistry of glasses. Chapman and Hall, New York (1982) 147-174.